

Warmup

UNDERFLOOR HEATING

240 Volt Installation Manual

TECHNICAL HELPLINE
888-WARMFEET/888-927-6333



SAFETY NetTM
GUARANTEE

IMPORTANT

Read this manual before attempting to install your underfloor heater. Incorrect installation could damage the heater and will invalidate your warranty.

Contents

- 3 Before you Start
- 4 Do's and Dont's / Installation tips
- 6 Heater information
- 7 Preparation & Electric Provision
- 12 Sub-floor preparation
- 14 Wiring configuration
- 15 Installing multiple heaters
- 16 **Installation step 1**
- 17 **Installation step 2**
- 18 Sizing Guide
- 19 **Installation step 3**
- 22 **Installation step 4**
- 23 **Installation step 5**
- 24 Limited Warranty & SafetyNet Guarantee
- 25 Terms and Conditions

WARMUP UNDERTILE SPACE HEATING CABLE FOR INSTALLATION IN FLOORS.

Your Warmup® Undertile™ Heater has been designed so that installation is quick and straight forward. As with all electrical systems, certain procedures must be strictly followed.

Warmup Inc, the manufacturer of the Warmup® Undertile™ Heating System, accepts no liability, expressed or implied, for any loss or consequential damage suffered as a result of installations which in any way contravene the instructions that follow.

Before you Start

Included with each Warmup heater system purchased should be the following:

- Primer
- Roller (to apply primer)
- Tape
- Installation Manual
- Thermostat

Double check your measurements and ensure you have the right heater sizes for the area you need to heat. Bear in mind that the heating element should not be installed under appliances or permanent fixtures and fittings such as refrigerators, washer/dryer, cabinets, tubs, vanity units etc. Below is a quick reference guide:

240 VOLT HEATERS

14 - 26 sq ft 1 x USDW330-240 undertile heater

27 - 32 sq ft 1 x USDW420-240 undertile heater

33 - 47 sq ft 1 x USDW650-240 undertile heater

48 - 64 sq ft 1 x USDW900-240 undertile heater

If you are missing any of the box contents or believe you have the incorrect heaters to cover the area required, please call 888-927-6333 for assistance.

There will be other materials you need to complete the project which are not included within the heating system. These include:

- Digital ohm multimeter - For space heating cable testing.
- A 4" double gang electrical box (for the thermostat) - with a plaster ring
- Tile installation products and tools.

**NOTE: Please ensure you do not damage the wire.
Be sure to test the system BEFORE you tile. See pg 16 for
more details.**

Do's and Don'ts

- DO** use a qualified installer.
- DO** check space heating cable with OHM meter.
- DO** carefully read this installation manual before commencing installation.
- DO** ensure the floor surface is smooth, clean and dry before priming the floor with Warmup® primer.
- DO** ensure good ventilation during application and drying of the thermal primer.
- DO** plan the heater layout and installation so that any drilling after tiling (e.g. for fixtures such as vanity units, tubs) will not damage the wiring. Remember to keep a copy for future reference.
- DO** maintain a gap of min. 2", max. 4" between the space heating cable runs at all times.
- DO** make sure that ALL space heating cable is positioned under the tiles in the installation.
- DO** protect the space heating cable, including the joint, with cardboard or hardboard between installation and tiling.
- DO** use thin set mortars and grouts (latex modified), suitable for use with underfloor heating (this will be specified in the manufacturers' instructions).
- DO** check that the heater is working immediately before commencing tiling.
- DO** take particular care when tiling not to dislodge or damage the space heating cable.
- DO** ensure that each tile is solidly bedded in tile adhesive, with no gaps or voids beneath.
- DO** remember to install the floor probe for the Warmup® thermostat.
- DO** make sure all electrical work is done by qualified persons in accordance with local building and electrical codes, the National Electrical Code (NEC), especially article 424, Part V of the NEC, ANSI/NFPA 70.
- DO** Call the Warmup Technical Helpline: 888-927-6333 if necessary.
- DO** ensure that you have electrical provision to run the heating system at 240 VAC, depending on the system you're installing.
- DO** remember to attach the rating labels included within this manual to the circuit breaker and thermostatic controls.
- DO** sketch a diagram of the space heating cable layout, which should be kept with the manual for future reference.

○ Do's and Dont's

- DON'T** attempt to connect the heaters to any power source prior to completion of installation.
- DON'T** install the space heating cable under any built-in items (i.e. tubs, vanity units, bookshelves, walls or partitions), or under any zero-clearance, dedicated-location furniture or appliances.
- DON'T** install the Warmup® Undertile™ Heating System heater under any floor other than ceramic, quarry or natural stone tiles.
- DON'T** commence installation on a mud job/screed that has not been fully cured.
- DON'T** allow traffic over the primed floor or the installed space heating cable before tiling.
- DON'T** shorten the space heating cable *at any time*.
- DON'T** allow the space heating cables to cross over or touch each other at any point.
- DON'T** store tiles, sharp or heavy objects on any of the wiring while tiling or bang a trowel on the installation area to remove excess mortar from the trowel.
- DON'T** commence tiling before testing the Warmup® Undertile™ Heating System.
- DON'T** switch on the installed heating system until tile adhesive has fully cured (1 - 3 weeks minimum), check adhesive manufacturer's instructions.
- DON'T** clear grout lines with a utility knife.
- DON'T** install the space heating cable on stairways, up walls or in closets.
- DON'T** attempt to repair the space heating cable if it becomes damaged. Call the technical helpline for further instruction:
888 WARMFEET/888-927-6333

Heater information

The heaters consist of a fixed length of space heating cable terminated at one end with 9' of unheated lead. We recommend you do not alter the length of the unheated lead, however if necessary, the wire can be extended if a UL-approved wire and connector box suitable for the purpose is used (e.g. waterproof if going into the floor, etc.). This must be carried out by a qualified electrician in accordance with local/state laws and guidelines.

Inspect the entire heater for damage, this includes the factory made joint and end termination. The joint and end termination cannot be altered or remade if damaged. If any parts are damaged contact the technical helpline (888-927-6333).

The core and ground braid are factory joined in a water resistant joint assembly to each supply conductor and ground conductor of the unheated lead. The unheated lead must not be reduced in length. Excess cable should be securely positioned inside the conduit in the wall.

240 Volt Loose Wire Heater Guide

No of heaters per 15 amp supply point	Heater Model	Wire Colors	Watts @ 240Vac	Nominal Wire Length (ft)	Nominal Amps Resistive (@240volts)	Nominal Resistance (ohms - cold)
11	USDW330-240	BLUE	330	72	1.36	176
8	USDW420-240	SILVER	420	112	1.76	136
5	USDW650-240	GREY	650	145	2.73	88
4	USDW900-240	RED	900	211	3.75	64

Warmup® Undertile™ Heating System is designed for use with ceramic, quarry or natural stone tiles. Use the Warmup Carbon Heater for heating under laminate, engineered wood or any other non-hard surface flooring.

Making electrical provision for the heater

For each Warmup® Heater you install, you will have 1 unheated lead running from the floor to the thermostat's electric connection. The joint connecting the unheated lead to the space heating cable must be at least 2 inches from the wall and placed in a position to be covered by tile and thin set mortar.

It may be necessary to chisel out short channels in the subfloor to minimize the increased height presented by the floor probe and the unheated lead.

All electrical connections should be done by a qualified technician.

Install to NEC and local BOCA codes.

Separate conduit will be required to run the unheated lead and the sensor wire back up to the thermostat. Please note that they cannot be placed within the same conduit. Neither the unheated lead or sensor wire must cross, or come into contact with, the heating element. **Bear in mind that you will need to make provision for drawing the unheated lead and sensor wire up through the conduit to the control box.**

Electrical Requirements

Please refer to the table on page 6 to calculate the amperage load for your particular system. For smaller areas, you may be able to utilize an existing circuit. In most cases, however, you will need a separate circuit to power the Warmup heaters.

The Warmup thermostat has a maximum resistive load of 15 amps (i.e. a maximum of 2 x USDW800). It also includes a built-in GFCI. If you want to control more than 15 amps worth of heating via a single thermostat you will need to use Warmup's master / relay configuration. Instead of using the thermostat, a different model of master thermostat is used to control individual switching units (each capable of switching up to a 15 amp load, and each containing its own GFCI). The relay units require their own separate electrical feed, and up to 10 relay units can be daisy chained to a single master unit via low voltage cabling. For further information please call the Warmup Helpline or visit www.warmup.com.

The thermostat should be connected to the main electrical supply via a fuse or circuit in accordance with the National Electrical Code. If the thermostat used does not include a **built-in Ground Fault Circuit Interrupter (GFCI)**, then one must be added to the circuit between the main power supply and the thermostat. If the thermostat does include a GFCI, it is **NOT** recommended to include another in the circuit, as this may cause accidental tripping of the control unit.

Ensuring Safety

Install the Warmup thermostat within the same room as the heater. In order to ensure the efficient running of the system within bathrooms, we recommend that the controls are located at least 36 inches away from shower openings or basin back splash areas so you minimize the possibility of exposure to water.

The rating label in this manual must be attached to the circuit breaker box for referral by the homeowner or electrical inspector. An additional smaller label is attached to the manual to be fixed adjacent to or on the thermostatic control.

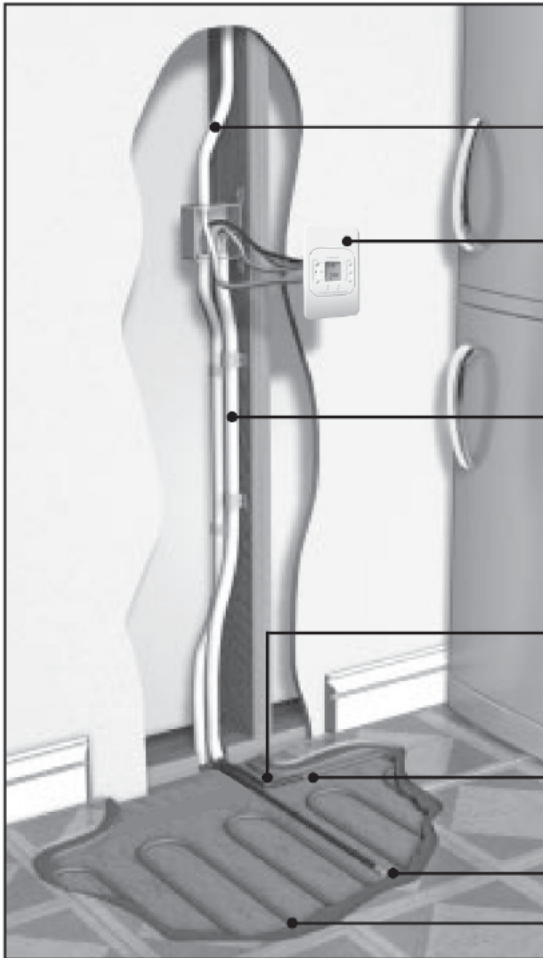

Mains supply via GFCI.

Warmup® Thermostat mounted on the wall.

Wires recessed into wall in metal or plastic conduit.

Unheated lead (minimum 2" length under tiled floor).

Factory made joint.

Temperature sensing floor probe.

Space heating cable

Note: the floor probe wire can be extended up to 150 feet

Do make sure all electrical work is done by qualified persons in accordance with local building and electrical codes, the National Electrical Code (NEC), especially article 424, Part V of the NEC, ANSI/NFPA 70.

Typical Wiring for a Thermostat GFCI Control to an Existing Breaker:

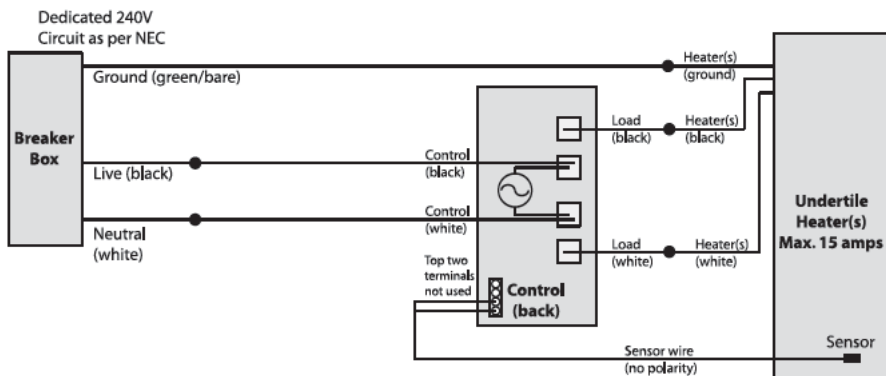

NOTE: All electrical work must be performed by a qualified electrician in accordance with local building & electrical codes and the National Electrical Code (NEC), especially Article 424, Part V of the NEC, ANSI/NFPA 70.

Typical Wiring for a Thermostat Control and Contactor to an Existing Breaker:

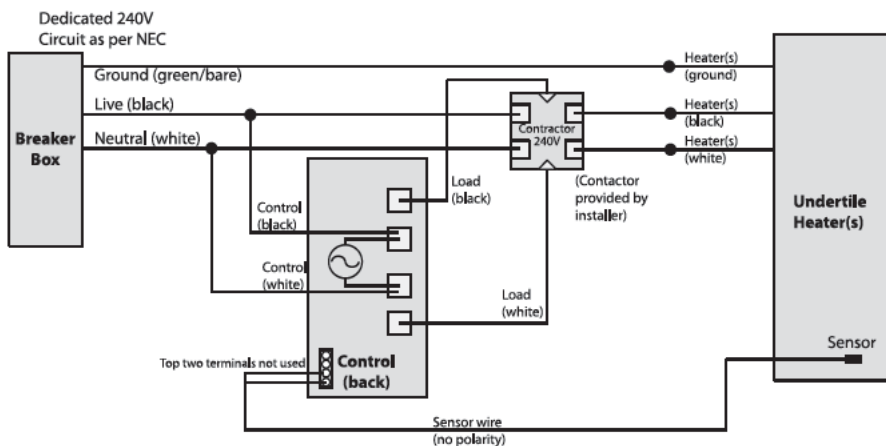

NOTE: All electrical work must be performed by a qualified electrician in accordance with local building & electrical codes and the National Electrical Code (NEC), especially Article 424, Part V of the NEC, ANSI/NFPA 70.

Master/Relay Cheat Sheet:

Disclaimer:

This sheet does not preclude or eliminate the need to read either the "Warmup Undertile Heater Installation Manual" or the installation instructions provided with the thermostats. This represents a breakdown of the material contained in the Master and Relay installation instructions, but is not a replacement for those directions. If you have any questions regarding the product or installation, please call (888) 927-6333, and one of our customer service representatives will be happy to assist you.

1. Each Slave (Relay) connects to 1-2 heaters

- a. Heaters are connected via the outside wires marked load (one black, one white) on the back of each Slave (Relay).
- b. The other two wires are marked 240VAC (one black, one white) and are connected to the dedicated circuit of 15 amps (@ 240V) provided for each individual slave.
- c. Connect Ground (green/bare) to line from home.

2. To connect Slaves (Relays)/Master Thermostat:

- a. This process requires using the terminals inside the Slaves (Relays) that are found by removing the face of each unit.
- b. **A sticker sits above this terminal labeled 1-4**
 - i. 1 and 4 are labeled "GND" for ground
 - ii. 2 is labeled "Drive"
 - iii. 3 is labeled "+12V"
- c. **The Wiring**
 - i. braided 18-22 gauge wire is required (to be supplied by a certified electrician)
 - ii. Wiring is a "daisy chain," requiring you to wire Slave (Relay) to Slave (Relay) to Slave (Relay)... etc.
 1. Wire "GND" 1 to "GND" 1
 2. Wire "Drive" to "Drive"
 3. Do not wire the second "GND" connection (marked under #4) - it will not be used. Also, do not use the "12VDC" connection as this will be used in the final wiring.
 4. Steps 1-3 apply to all Slave (Relay) connections.
 5. Final Slave hookup to Master Thermostat
 - a. The final slave that connects directly to the Master Thermostat is wired the same as in Step 2. In addition, the connection marked "12VDC" must also be wired to the Master Thermostat (refer to diagram).
 - i. This last connection is what provides power to the programmable Master Thermostat.
 - ii. This requires no additional circuit or connections.
 - b. The bottom two connections that are marked with a symbol (a circle surrounds a jagged line, refer to diagram) is connected to the floor probe
 - i. Floor probe must be at least 12 inches into the floor
 - ii. Must have at least a 1-inch clearance on either side from heater wires.

Master/Relay Wiring

Models Addressed:
CT230-240GA
TH115-F-12VDC

IMPORTANT:

Connections from models CT230-120GA/CT230-240GA to other CT230-120GA/CT230-240GA or to the Master Thermostat TH115-F-12VDC are made using 18-22 Gauge stranded conductor wire.

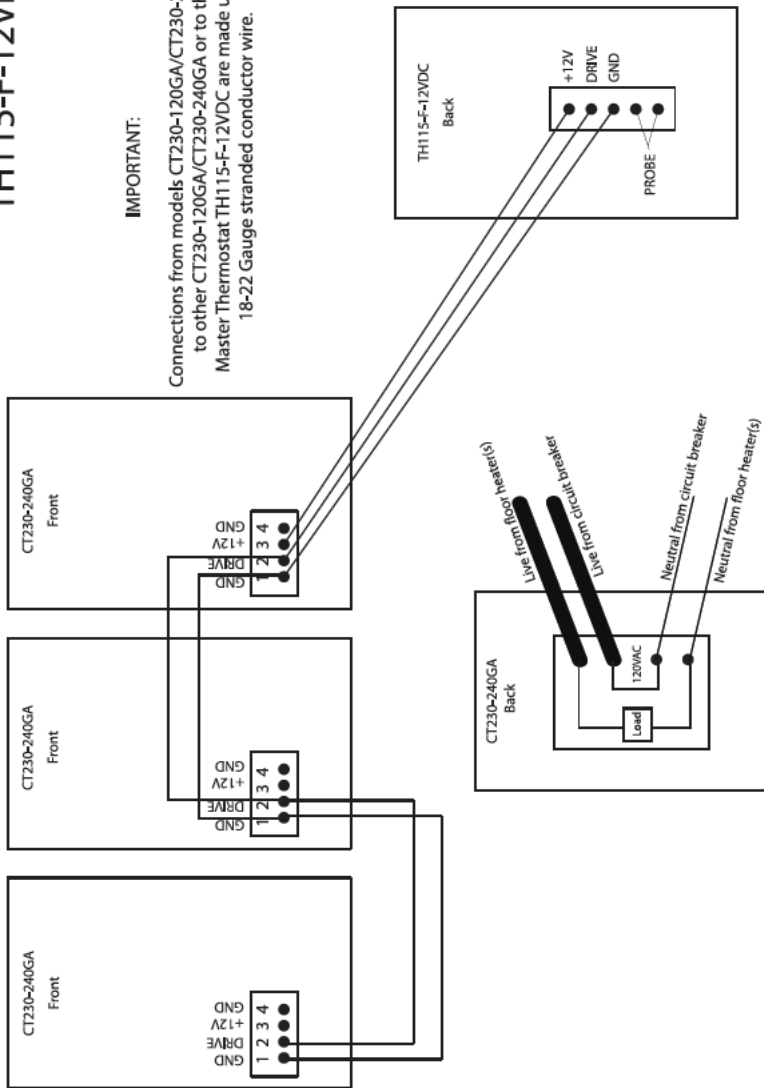

○ Subfloor preparation - technical notes

To fully utilize the long-term durability of ceramic tiling, whether heated or not, it is important that the design, construction and preparation of the subfloor is carried out correctly.

It is essential that the sub-floor be sufficiently rigid to support the ultimate weight that it will have to bear without movement or deflection.

The choice of products for subfloor preparation and tile will vary depending on the existing subfloor, preferred tiling system and choice of tile. This document is only intended to be an outline guide to laying ceramic floor tiles. Further help regarding floor preparation and tile application is available from the tile adhesive manufacturers and/or the Tile Council of America (TCA) Tel: 864-646-8453, website: www.tileusa.com. Alternatively, you may wish to seek professional advice e.g. an architect/contractor.

Subfloor Preparation

Prior to heater installation, it is important that the subfloor is properly prepared as per Tile Council of America Guidelines.

WOOD SUBFLOOR: Boards need to be of suitable material or requires backer board. Chipboard and O.S.B. boards (flake boards) are not suitable bases for ceramic floor tiling.

SUBFLOOR PREVIOUSLY COVERED IN LINOLEUM, CORK OR CARPETING: All old flooring and adhesive must be removed. If bitumen is present as adhesive residues it must be removed. If the bitumen is a damp proofing membrane or isolation membrane it must be covered with a minimum 2" of sand/cement self leveler, taking care not to puncture the bitumen coating. If using other damp proofing or tanking systems, contact the manufacturer for advice.

We strongly recommend installing tile and stone flooring according to manufacturer's recommendations, TCA guidelines and ANSI specifications.

Special Precautions

MOSAIC TILE AND PORCELAIN: When installing mosaic tile and CERTAIN PORCELAIN, we recommend a two-step process. Cover the space heating cable with latex self-leveling compound before tiling to ensure a flat, smooth surface, then thin set the mosaic according to typical practice.

EXPANSION JOINTS: Do not install the space heating cable through an expansion joint. Install the space heating cable right up to the joint, if necessary, but do not bridge the joint.

INSULATION: Do not install rigid insulation directly above or below backer board or mortar. If possible, install insulation as shown in diagrams.

Insulation dramatically enhances the performance and efficiency of floor warming systems.

Preparation of wood or concrete subfloor

The Heater wire installation shall be in accordance with one of the illustrated methods as per this manual. The heater wire is not intended to be installed directly upon the subfloor.

Using plywood

Ensure adequate underfloor ventilation.

Secure existing floorboards and if necessary, pre-level with a latex cement self-levelling compound to give a flush fit for the subsequently applied plywood.

Refer to Tile Council of America guidelines regarding sealing the backs and edges of the plywood before attaching.

Attaching ply directly to the joists will not provide a sufficiently stable floor finish to accept tiles; fitting tongue and groove flooring and then over-boarding with ply or a tile backer board is recommended. A rigid base is essential.

Using insulated tile backer board

Attach the tile backer board as per manufacturer's instructions.

For best results and for ease of installation, Warmup recommends the use of an extruded polystyrene building or insulated tile backer board with a cement-based facing, such as Warmup Insulation Board.

After attaching the board to the subfloor, the Warmup Undertile Heating System may be laid directly on top of the tile backer building board, and then tiled over. It is important to ensure that the tile adhesive and grout used are flexible and that the tile backer building board has been fitted as per the manufacturer's instructions. High quality, cement-based adhesives with their flexible additives are most suitable.

NOTE: Do not use the green Warmup primer when installing on insulated tile backer board.

The above is for general guideline use only. Installations and subfloor work must be as per Tile Council of America Guidelines.

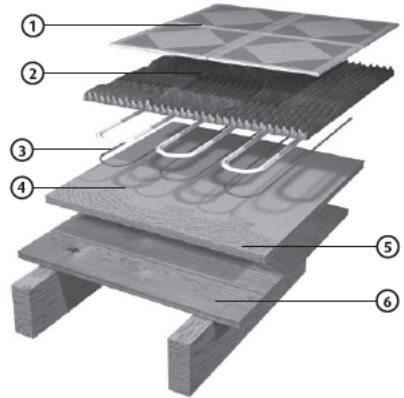

- ① Tiles
- ② Flexible tile adhesive
- ③ Heating wire
- ④ Primer
- ⑤ 3/4" plywood or Warmup Insulation Board
- ⑥ Floor boards or 1st layer of plywood

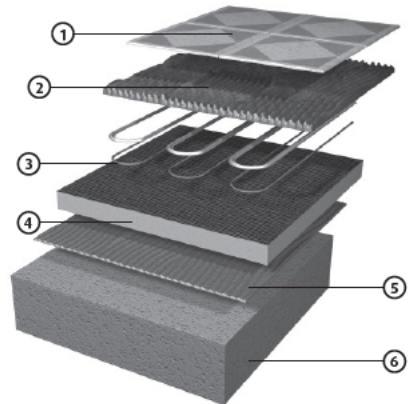

- ① Tiles
- ② Flexible tile adhesive
- ③ Heating wire
- ④ Warmup Insulation board
- ⑤ Insulation board adhesive
- ⑥ Subfloor (concrete or timber)

The above is for use as a general guideline only. Installations and subfloor work must be as per Tile Council of America Guidelines.

Wiring configurations

The heating cable shall not extend beyond the room or area in which it originates.

Before installing the heaters, refer to the sizing guide on page 18 of this booklet to ensure you have the proper number and size of heaters for the area you wish to heat. The sizing guide will also give you the perimeter and heating wire spacing required for your particular room size.

While the installation instructions only make provision for the wiring to be installed in a set configuration, there are many instances where departure from this configuration may be desirable. Below are a few drawings illustrating the versatility of the Warmup® Undertile™ Heating System.

In each of the examples, the floor space is heated using different wire configurations to suit the particular layout of the room. It should be noted that while the sizing chart provided in this booklet is a useful guide to heater layout, it may be necessary to slightly alter the heating wire spacing to suit your particular installation. However, at no time should the spacing between the wires be less than 2" or greater than 4".

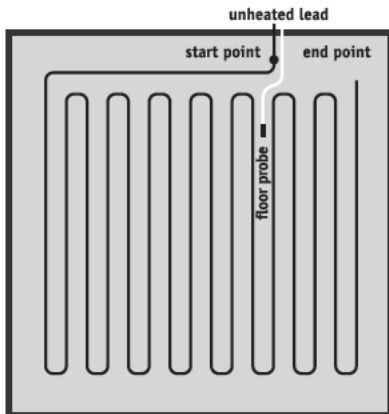

Standard room

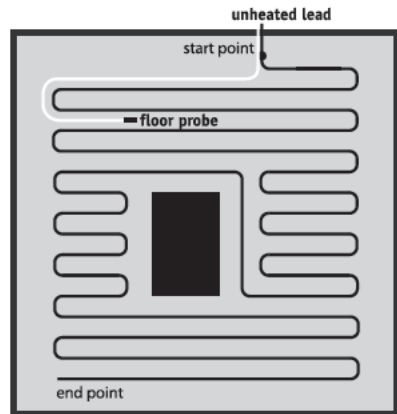

Room with central obstacle

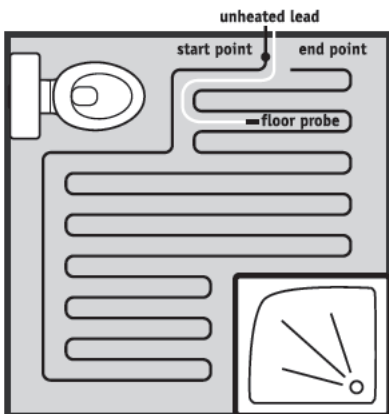

Bathroom

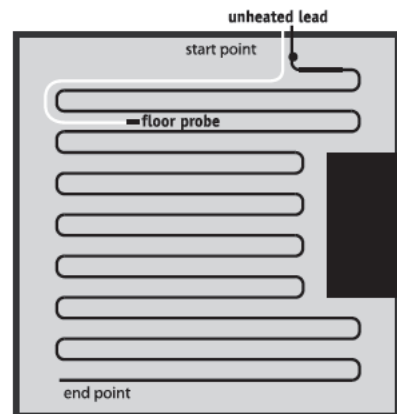

Standard room with recesses

Installing multiple undertile heaters

When installing two or more heaters, begin by reading the sizing guide on page 18 of this booklet to ensure you have the proper number and size of heaters for the area you wish to heat. The sizing guide will also tell you the perimeter and space heating cable spacing required for your particular room size.

After you prime the subfloor, mark the subfloor as per the instructions on page 17 and lay the first heater. Do not cover the first heater with tape at this point as you may wish to slightly alter the spacings later on. Lay the second heater in the remaining area using the same perimeter and space heating cable spacings as the first heater and test the second heater.

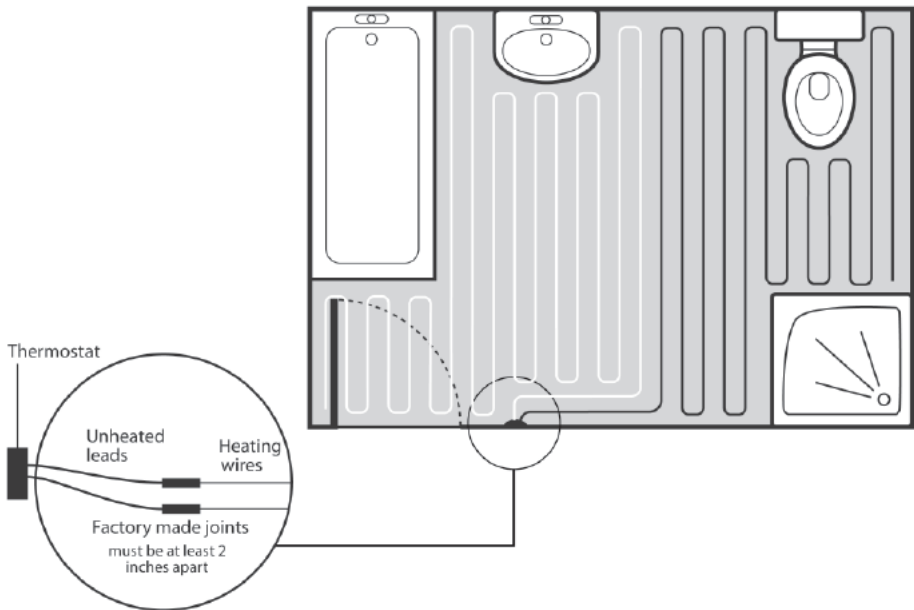

When laying more than one heater, it is important to keep these points in mind:

- 1 The space heating cables **may not touch** or cross at any point.
- 2 The heaters are joined in parallel only at the Thermostat.
Do not attach one heater to another in series.
- 3 The space heating cable spacings for all heaters in an area should be approximately **equal**.

Installation step 1

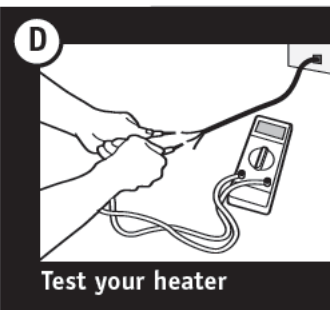
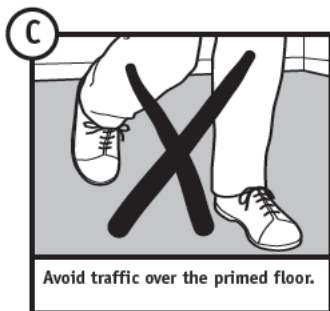
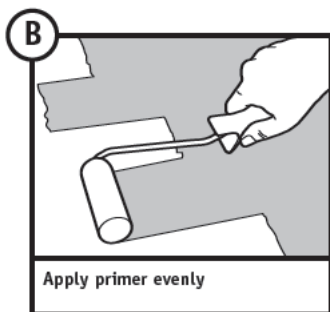
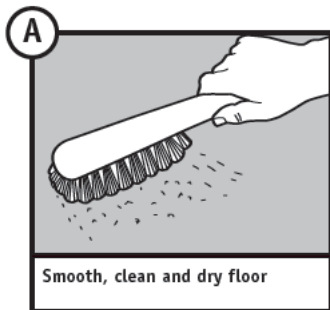

Paint the subfloor with Warmup® primer*.

Before applying the primer ensure that the floor surface is smooth, dry and free from dust or grease.

If necessary, an appropriate smoothing compound should be applied and allowed to cure.

If the heater is being fitted to a solid floor it is essential that the concrete slab has been allowed to cure before the primer is applied. This can take 8 weeks or more.

If tiling on existing ceramic or quarry floor tiles, clean the floor with an appropriate floor-cleaning compound. **Do not** apply the green Warmup® primer; go to installation step 2.

If tiling on water proof/resistant surface (ie Hardibacker) **do not** apply the green Warmup® primer; go to installation step 2.

Using the roller supplied, apply the primer evenly to the entire surface to be heated.

The primer must be allowed to dry for a minimum of 3 hours. The light green color of the primer will change to a darker green once dry and will be slightly sticky. Good ventilation must be provided which, along with a higher ambient air temperature, will accelerate the drying process.

Avoid traffic over the subfloor once the primer has been applied.

IMPORTANT! – Test the Heater

Strip the ends of the cold lead wire and test the black & white cables to ensure the heater is working properly.

Using a digital ohmmeter or multi-meter, check the resistance of the space heating cable and continuity of the protective ground braid. Please note that analog meters with a moving needle are not sufficiently accurate for testing the Warmup heater.

Set your Ohm meter to measure resistance in 0 – 200 Ohms.

Acceptable readings of these ohms resistance measurements (between the black & white wires) should fall within +/- 15% of the values indicated on page 6.

There should NOT be any continuity between the ground wire and either of the white neutral wire or the black live wire. Any continuity indicates there is a short in the circuit.

Installation step 2

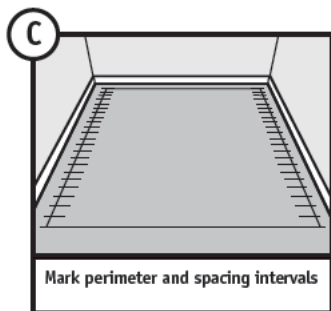
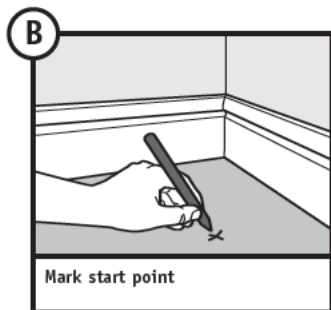
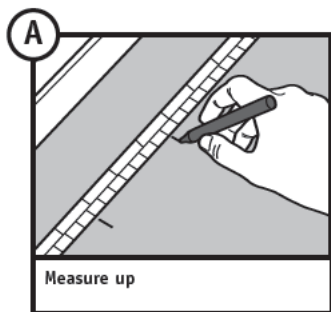

Mark the heater position on the floor.

Calculate in square feet the size of the area to be heated. Then, using the sizing guide on the opposite page, refer to the space heating cable spacing and perimeter distances to correctly fit your space heating cable into the space available.

Using a fiber tipped pen, mark a start point as close as possible to the power supply, but no further than 8 feet from it using the sizing guide on the opposite page.

Mark all the outer corners of the heated area observing the perimeter distances referred to in the sizing guide and join the corners up to form a marked out perimeter.

Mark up the spacing intervals for the space heating cable following the sizing guide.

The spacing between heater cables must be a minimum of 2" apart, but not further than 4" apart. At no time, should the space heating cables be less than 2" from the wall.

Note: The entire heater must be kept on the same level; do not lay the heaters on stairways or up walls.

Sizing guide

If your area is above 235ft² please contact the Warmup Technical Helpline on 888-927-6333 for assistance.

240 volt sizing guide

Area (sq ft)	Heater(s)	Spacing in (s)	Perimeter in (p)
15-16	USDW320-240	2 1/4	2
17-18	USDW320-240	2 3/4	2
19-20	USDW320-240	3 1/4	2
21-24	USDW320-240	4	2
25-26	USDW420-240	2 3/4	2
27-28	USDW420-240	3 1/4	2
29	USDW420-240	3 1/4	2
30-32	USDW420-240	2 2/4	2
33-34	USDW420-240	4	2
35	USDW650-240	2 1/4	2
36-41	USDW650-240	2 3/4	2
42-44	USDW650-240	3 1/4	2
45-49	USDW900-240	2 1/4	2
50-56	USDW900-240	2 3/4	2
57-59	USDW900-240	3 1/4	2
60-68	USDW420-240+USDW650-240	2 3/4	2
69-72	USDW420-240+USDW650-240	3 1/4	2
73-74	USDW420-240+USDW650-240	3 2/4	2
75-78	USDW900-240+USDW420-240	2 3/4	2
79-87	USDW900-240+USDW420-240	3 1/4	2
88-89	USDW900-240+USDW420-240	3 2/4	2
90-92	USDW650-240+USDW900-240	2 3/4	2
93-98	USDW650-240+USDW900-240	3	2
99-104	USDW650-240+USDW900-240	3 1/4	2
105-106	2xUSDW900-240	2 3/4	2
107-112	2xUSDW900-240	3	2
113-119	2xUSDW900-240	3 1/4	2
120 upwards	2xUSDW900-240	3 1/4	4

NOTE: All spacing has been based on square areas for calculation purposes. Therefore, actual spacing will vary according to the shape of the area to be heated.

Installation step 3

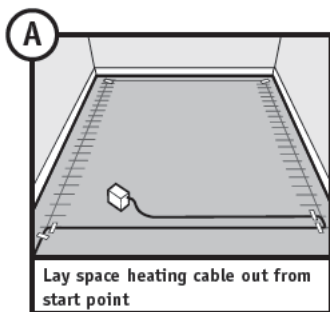

Once the floor has been marked up, the space heating cable can be laid out. Test heater throughout installation.

Gently pull the unheated lead from the box.

Do not remove the spool from the box as this will cause the space heating cable to twist.

After 9 feet of cable has been removed, you will reach the point at which the unheated lead joins the space heating cable.

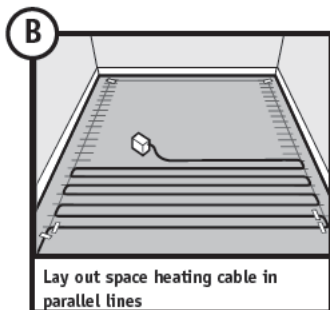

The joint should be taped to the floor at the start point. Ensure that the factory joint lays flat on the floor. Care should be taken to ensure that the factory joint remains horizontal, and within the area to be tiled. The joint should not be bent at point of entry into the conduit as this may damage both the factory joint and /or the heating element within.

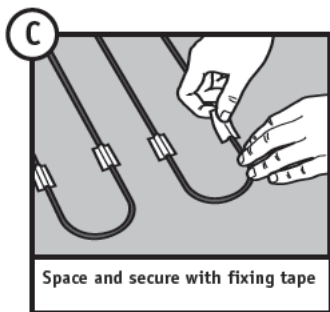

The space heating cable should be laid in parallel lines back and forth across the main body of the area to be heated.

Using the cable spacing markings as tape down points, secure the space heating cable to the floor with strips of adhesive tape supplied.

The strips should be about 1 inch long.

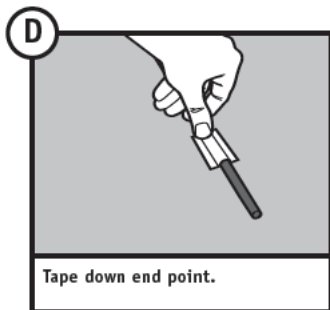

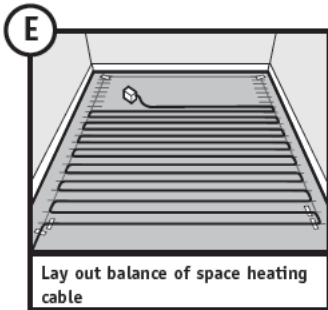

You may wish to alter the space heating cable layout to fit your particular room.

Where there are irregularities of room shape you can adjust the layout of the space heating cable to provide warmth around the sinks, tubs, toilets, etc. (see layout diagram page 14).

This is quite acceptable providing that:

- The space heating cables are spaced at least 2" apart at all times.
- The space heating cables never cross.

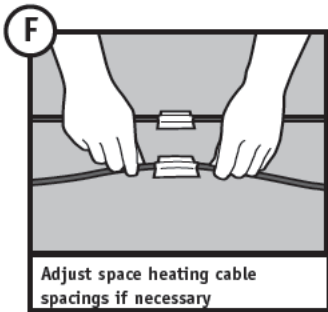

IMPORTANT! – Test the Heater

Once the space heating cable layout has been completed, ensure that the heater is working properly.

Using a digital ohmmeter or multi-meter, check the resistance of the space heating cable and continuity of the protective ground braid. Please note that analog meters with a moving needle are not sufficiently accurate for testing the Warmup heater.

Set your Ohm meter to measure resistance in 0 – 200 Ohms.

Acceptable readings of these ohms resistance measurements (between the black & white wires) should fall within +/- 15% of the values indicated on page 6.

There should NOT be any continuity between the ground wire and either of the white neutral wire or the black live wire. Any continuity indicates there is a short in the circuit.

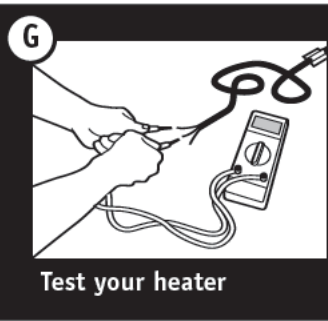

The entire length of the space heating cable should then be taped to the floor.

Ensure the greatest possible adhesion, with the minimum of trapped air space beneath the taped space heating cable. After applying a length of tape, run your forefinger and thumb along the length of the space heating cable, gently squeezing the space heating cable to remove any air space between the space heating cable and the tape. As you apply the tape, gently tighten the space heating cable from the ends to ensure it is straight.

The space heating cable should be located in the center of the tape to provide maximum protection from the tiler's trowel. If the tape is not completely covering the space heating cable at any point, apply another layer of tape to provide additional protection.

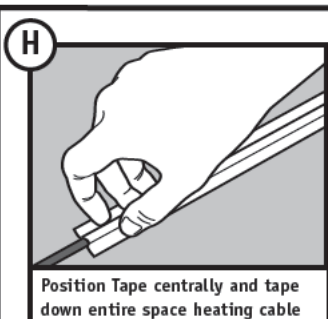

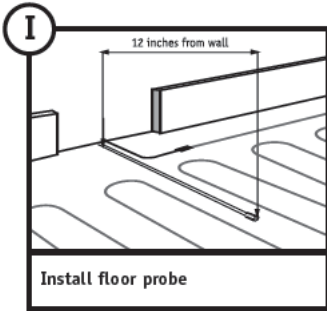

The end of the probe wire contains a capped sensor that should be centered between two space heating cables at least 12" into the heated area. At no time should the probe wire cross the space heating cable.

Depending on the requirements of the tiler, it may be necessary to chisel out short channels in the subfloor to minimize the increased height presented by the floor probe and the unheated lead provided for connection to the thermostat or mains supply.

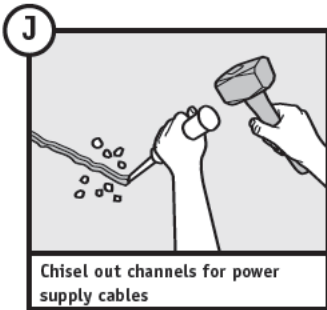

Before chiseling the area, ensure that the space heating cable, unheated lead and floor probe are protected to avoid damage during chiseling. Place the unheated lead and floor probe into the channels and secure with fixing tape.

Remove all debris and chippings from the floor. Unless the floor is being tiled immediately, cover the floor with cardboard to protect the space heating cable and floor probe.

Installation step 4

Although the Warmup® system is designed to be installed by any competent do it yourselfer, only a qualified electrician should undertake the wiring and connecting of the heaters to a thermostat. This is to safeguard against the risk of personal injury and to ensure that any installation complies with National and local codes.

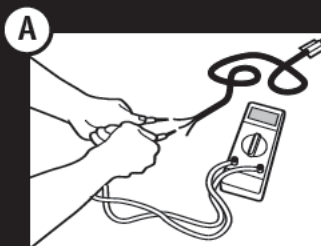

Check resistance using multi-meter

IMPORTANT! Test the heater

Before tiling, ensure that the heater is working properly by using the method described on page 16.

Test the probe wire:

Temperature sensor wire must be verified before and after installation. For probe resistances, refer to the thermostat instructions.

Install Warmup® Thermostat and floor probe.

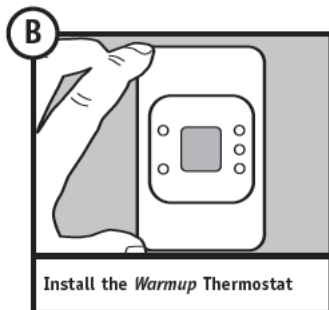

Install the Warmup Thermostat

Install the Warmup® Thermostat.

Instructions for the fitting of the Warmup® Thermostat can be found inside the thermostat box.

Each heater has one unheated lead. The unheated lead consists of one white wire (neutral), one bare copper wire (protective ground) and one black wire (live). Please review the information on pages 7 through 9 before proceeding.

The bare copper (protective ground) wire leading from the unheated lead should be connected to the ground leading from the power supply.

Floor probe location

The floor probe wire for the Warmup thermostat will be approximately 15 feet long.

The end of the wire contains a capped sensor that should be centered between two space heating cable at least 12" into the heated area. At no time should the probe wire cross the space heating cable.

If the heater does not pass either test, **DO NOT TILE**. Call the technical helpline on 888-WARMFEET. (927-6333)

Completely disconnect the heater prior to and during tiling.

Ensure that safety labels contained within this manual are placed by the breaker box and near the control as described.

Installation step 5

Check the heater resistance with a digital multi-meter every half hour or so. If the heater goes open circuit (no reading on the multi-meter) **DO NOT CONTINUE** - call the technical helpline on 888-WARMFEET (927-6333).

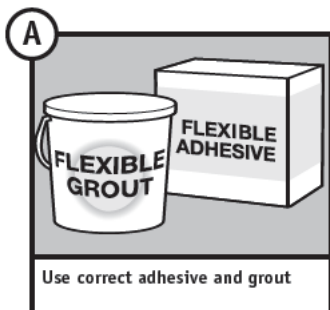

Tile and grout

The thin set mortar and grout must include an additive for flexibility and be suitable for use with underfloor heating. Refer to the manufacturer's instructions for usage.

Check that the space heating cable is fully taped and secure. Tile as normal, taking care not to damage or dislodge the space heating cable with the trowel or with the tiles. If tiling with mosaic or similar tiles, it is advisable to cover the space heating cable with latex self-leveling compound before tiling to ensure a flat, smooth surface.

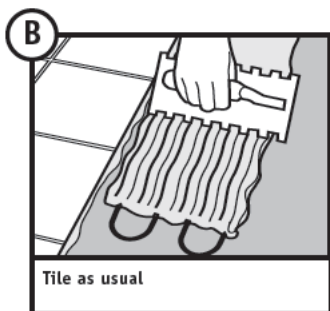

When selecting a trowel, we recommend 3/8" x 1/4" or greater. When using a notched trowel, gently comb the adhesive in straight lines in the same direction as the runs of the space heating cable. The trowel should be used at an angle of approximately 45 degrees to the floor.

Do not allow the trowel to make contact with the space heating cable while applying the mortar. Use sufficient mortar to ensure that there are no voids or hollows under the tile.

If a tile has been positioned incorrectly, take great care not to damage the space heating cable when lifting.

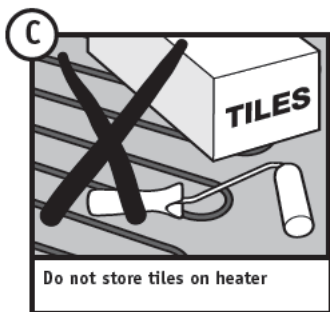

Remember that tiles must not be lifted once the mortar is dry, as this will damage the space heating cable. **Do not** store or cut tiles on top of the space heating cable. **Do not** allow chippings or dust to contaminate the floor during tiling.

Care must be taken not to damage the space heating cable during the tiling process. Use a piece of carpet, cardboard or a dustsheet as a "crawl-board" to prevent the space heating cable from being damaged by your feet or knees during the tiling process.

Grout the floor as soon as possible as per the ceramic tile adhesive manufacturer's instructions. The heater should not be made fully operational until such time as the tile or concrete installer verifies that the cement materials are fully cured (1-3 weeks).

Installation step 6

Fill out your warranty card.

WARMUP 30-YEAR WARRANTY

Models:

USDW heaters and USDW-M heaters sold by Warmup, Inc.

THE WARMUP 30-YEAR WARRANTY DOES NOT EXTEND TO THERMOSTATS, WHICH ARE COVERED BY A ONE-YEAR GUARANTEE FROM THE DATE OF ORIGINAL PURCHASE.

GOVERNING LAW. Unless otherwise governed by applicable state law, this warranty shall be interpreted and enforced in accordance with the laws of the State of Connecticut.

This 30-Year Warranty applies:

1. Only to the original homeowner(s) from the date of purchase
2. Only if the unit is registered with Warmup within thirty (30) days after purchase. Filling out the card accompanying this warranty in its entirety will complete registration. In the event of a claim, proof of purchase is required, i.e.: invoice and receipt. Such invoice and receipt should state the exact model that was purchased; and
3. Only for the duration of the Lifetime of the floor covering under which it was originally installed if the purchaser of the heater remains the owner of the residence in which it is installed. If the original purchaser sells such residence, the warranty will transfer and continue for the duration of the 30 years from date of purchase.
4. Only if the heater has been grounded and protected by a GROUND FAULT CIRCUIT INTERRUPTOR (GFCI) at all times.

COVERAGE

- 1) The warranty period begins on the date of purchase. Registration is effective only when a letter of confirmation is sent by Warmup, Inc.
- 2) Warmup's Undertile Heater is guaranteed by WARMUP, INC. ("Warmup") to be free from defects in materials and workmanship under normal use and maintenance for thirty (30) years, provided the Product is installed in accordance with the accompanying Warmup installation manual, any special written design or installation guidelines by Warmup, Inc. for a particular project, the National Electrical Code (NEC) and all applicable local building and electrical codes; and
- 3) Provided Warmup heaters are installed under ceramic tile, marble and natural stone surfaces.
- 4) During the period of Warranty, Warmup will arrange for the heater to be repaired or (at its discretion) have parts replaced free of charge. The costs of repair or replacements are your only remedy under this Warranty. Such cost does not extend to any cost other than direct cost of repair or replacement by Warmup and does not extend to costs of relaying, replacing or repairing any floor covering or floor.
- 5) If Warmup, Inc. determines the repair of the product is not feasible; we will replace the product with equal or similar features and functionality at Warmup's sole discretion. WARMUP'S MAXIMUM LIABILITY IS LIMITED TO THE ORIGINAL PURCHASE PRICE OF THE HEATER MULTIPLIED BY THE PERCENTAGE OF THE WARRANTY PERIOD REMAINING.

SAFETYNET GUARANTEE GUIDELINES

1. Purchase a Warmup Undertile Heating Kit, and follow all recommended installation procedures in the Installation Manual. Failure to follow the instructions will invalidate the guarantee.
2. If you make a mistake and cut or damage the new heating before tiling, return the damaged heater to Warmup within 30 DAYS along with your original dated sales receipt. WARMUP WILL REPLACE ANY PRE-TILED HEATER (MAXIMUM 1 HEATER) WITH ANOTHER HEATER OF THE SAME MAKE AND MODEL – FREE.
3. If you cut or damage the new heating during or after tiling, contact Warmup immediately for technical support. Warmup will mail a repair kit and instructions at no charge to the installation site within 24 hours. Limit of one free repair kit per customer or installer.

Please note :

(i) Repaired heaters carry a 5 year warranty only. Under no circumstances is Warmup responsible for the repair or replacement of any tiles which may be removed or damaged in order to affect the repair.

(ii) The Safety Net Guarantee does not cover any other type of damage, misuse, or improper installation due to improper adhesive or subfloor conditions. Limit of one free replacement heater per customer or installer.

Exclusions and Terms and Conditions

EXCLUSIONS

Warmup, Inc. shall in no event be liable for incidental or consequential damages, including but not limited to extra utility expenses or damages to property. This Warranty is null and void if

- 1) The floor covering over the heater(s) is damaged, lifted, replaced, repaired or covered with subsequent layers of flooring.
- 2) The heater fails due to damage caused during installation or tiling, unless damage is caused directly an employee of Warmup. It is therefore essential to check that the heater is working (as specified in the installation manual) prior to tiling.
- 3) Damage as a result of floods, fires, winds, lightning, accidents, corrosive atmosphere or other conditions beyond the control of Warmup, Inc.
- 4) Use of components or accessories not compatible with Warmup heaters
- 5) Warmup products installed outside the United States.
- 6) Parts not supplied or designated by Warmup, Inc.
- 7) Damage or repair required as a result of any improper use, maintenance, operation or servicing.
- 8) Failure to start due to interruption and/or inadequate electrical service
- 9) Any damage caused by frozen or broken water pipes in the event of equipment failure.
- 10) Changes in the appearance of the product that does not affect its performance.
- 11) The owner, or his/her designated representative, attempts to repair the product without receiving prior authorization from Warmup. Upon notification of a repair problem, Warmup, Inc. will issue an Authorization to Proceed under the terms of this Warranty.

If Warmup is required to inspect or repair any defects caused by any exclusions referenced above, all work will be fully chargeable at Warmup's inspection and repair rates then in effect.

WARMUP, INC. DISCLAIMS ANY WARRANTY NOT PROVIDED HEREIN, INCLUDED ANY IMPLIED WARRANTY OF THE MERCHANTABILITY OR IMPLIED WARRANTY OF FITNESS FOR A PARTICULAR PURPOSE. WARMUP, INC. FURTHER DISCLAIMS ANY RESPONSIBILITY FOR SPECIAL, INDIRECT, SECONDARY, INCIDENTAL, OR CONSEQUENTIAL DAMAGES ARISING FROM OWNERSHIP OR USE OF THIS PRODUCT, INCLUDING INCONVENIENCE OR LOSS OF USE. THERE ARE NO WARRANTIES THAT EXTEND BEYOND THE FACE OF THIS DOCUMENT. NO AGENT OR REPRESENTATIVE OF WARMUP, INC. HAS ANY AUTHORITY TO EXTEND OR MODIFY THIS WARRANTY UNLESS SUCH EXTENSION OR MODIFICATION IS MADE IN WRITING BY A CORPORATE OFFICER.

DUE TO DIFFERENCES IN BUILDING AND FLOOR INSULATION, CLIMATE AND FLOOR COVERINGS, WARMUP, INC. MAKES NO REPRESENTATION THAT THE FLOOR TEMPERATURE WILL ACHIEVE ANY PARTICULAR TEMPERATURE OR TEMPERATURE RISE. UL STANDARD LISTING REQUIREMENTS LIMIT THE HEAT OUTPUT OF WARMUP UNDERTILE HEATING, AS SUCH, USERS MAY OR MAY NOT BE SATISFIED WITH THE FLOOR WARMTH THAT IS PRODUCED. WARMUP DOES WARRANT THAT ALL HEATERS WILL PRODUCE THE RATED WATT OUTPUT LISTED ON THE HEATER NAMEPLATE, WHEN OPERATED AT THE RATED VOLTAGE.

TERMS AND CONDITIONS

Shipping Discrepancies:

Incoming materials should be inventoried for completeness and for possible shipping damage. Any visible damages or shortages must be noted prior to accepting the material. Any discrepancy concerning type or quantity of material shipped, must be brought to the attention of your Warmup® reseller within 15 days of the shipping date entered on the packing slip for the order.

Miscellaneous:

The terms of this Limited Warranty are exclusive and supercede any other warranty or terms and conditions relating to the subject matter whether included in a purchase order for this product or in any other document or statement.

If you need assistance or have any questions, please contact Warmup, Inc. at 888-927-6333 or visit our website at warmup.com

COMPLETE AND RETURN WARRENTY REGISTRATION TO WARMUP, INC (Please Print)
Alternatively you can register online at warmup.com

FULL NAME _____
STREET _____
CITY _____ STATE _____
ZIP CODE _____ TELEPHONE # _____
E-MAIL _____
PURCHASED FROM _____
CITY _____ STATE _____
INSTALLER NAME _____
DATE OF PURCHASE _____

PLEASE STATE WHICH ROOM THE HEATER(S) IS INSTALLED:

A ROOM (circle one)	B RESISTANCE READING (OHMS) HEATER	C PROBE	D TOTAL SQ FT PER ROOM
KITCHEN	_____	_____	_____
BATHROOM	_____	_____	_____
SUNROOM	_____	_____	_____
HALL	_____	_____	_____
OTHER	_____	_____	_____

HOW DID YOU HEAR ABOUT WARMUP? (please check one)

Showroom Website Home/Trade Show Electrical Contractor
 Tile Contractor Friend Architect/Designer
 Magazine(which one) _____

Other _____

Type of Project:

New Construction Remodeling

I hereby confirm that I have read and understand the contents of the Installation Manual, and that the heater has been installed as specified therein. I acknowledge that no claim can be brought against the manufacturer or its agents for any consequential loss or damage whatsoever.

Signed _____

Dated _____

*Postage
Required*

Warmup, Inc
52 Federal Road
Unit 1F
Danbury CT 06810